

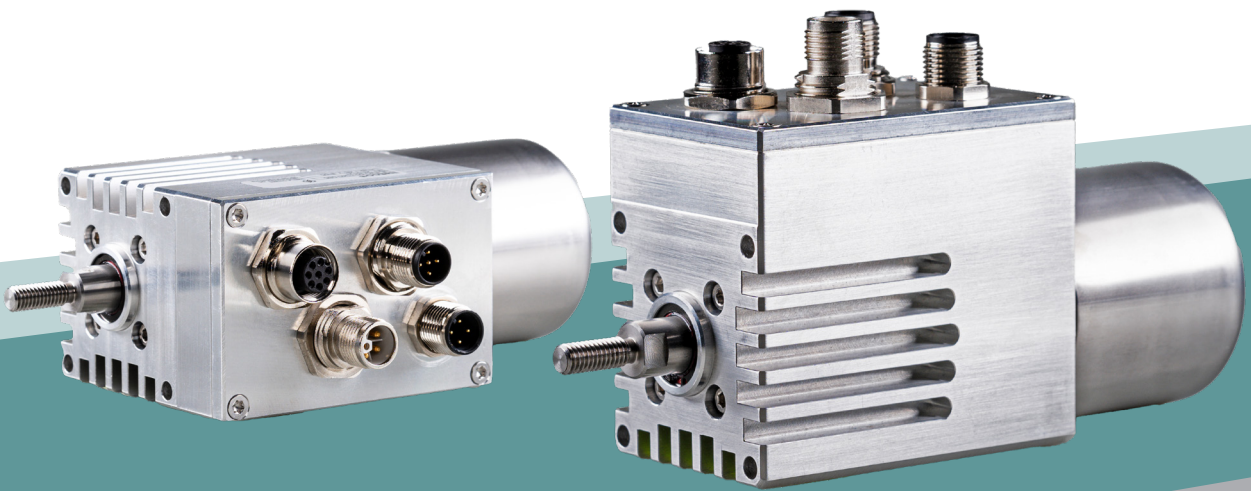

SMELA
SMART ELECTRIC ACTUATORS



liteECO[®] INTEGRATED series

Linear actuators for short stroke movements
up to 115 mm stroke and 750 N force (static)
with integrated motion controller

liteECO® INTEGRATED linear actuators

LINEAR TELESCOPABLE ELECTROMECHANICAL CONCEPT

Most compact pneumatic alternative for short stroke movements

SMELA liteECO® series are the most compact electromechanical alternative to pneumatic short-stroke cylinders due to their patented telescopic concept of motor and mechanics. This makes them ideal for linear movements often required in production lines, machine tools or packaging systems.

A servo motor incl. positioning sensor enables the movement of simple to complex profiles: for fixing, adjusting, locking and following any motion profile. The highly efficient motor not only saves up to 90 % of the energy compared to pneumatic systems. Together with the smart arrangement of the mechanics, it saves up to 80 % of installation space compared to existing electrical solutions. In addition, the liteECO® series offers the possibility of a simple refurbishment. Replacing worn mechanics is very easy and helps the drives to achieve several life cycles: sustainable, cost- and resource-saving.

In addition to the servomotor and the linear mechanics, the LE-INTEGRATED actuators have an integrated motion controller based on 24 volts and optionally on 48 volts. The actuators are controlled via EtherCAT, CANopen or digital IOs. As with the BASE series, many advantages of electric drives are combined with essential features for high industrial requirements and packed into the smallest possible installation space. In addition to sealing to the degree of protection IP65, conventional M8 and M12 circular connectors have been integrated in the codings A, B, L and Y. The maximum stroke is 85 or 115 millimetres, whereby any positioning within the maximum stroke is possible.



Advantages

- High power and dynamics in a compact design
- High utilization of the installation length for the stroke
- Up to 90 % energy savings compared to pneumatics
- Up to 80 % installation space savings compared to electrical alternatives

Features

- Integrated motion controller
- EtherCAT, CANopen and/or digital IO interfaces
- Robust M8 and M12 circular connectors
- Degree of protection IP65*

Product configuration

LE- - - - . - . - - - . - - -

Stroke length

085	85 mm
115*	115 mm

Lead screw type and pitch (mm/revolution)

Pitch	High helix	Trapezoidal
2	-	T020
4	-	T040
10	S100	-
15	S150	-
24	S240	-

other thread configurations on request

Size | Flange width

50	Load capacity up to 750 N (depending on lead screw type)
....	Further sizes to follow

liteECO® INTEGRATED Interface configuration

IDIO.A	Digital IO, M12 Connector variant (A - Automotive)
ICAT.A*	EtherCAT, M12 Connector variant (A - Automotive)
ICAT.S*	EtherCAT, M8 Connector variant (S - Standard)
ICAN.S*	CANopen, M8 Connector variant (S - Standard)

* on request/planned

Technical data, dimensions

Size | Flange width 50

Characteristics (depending on stroke length)	085	115
Stroke S [mm]	85	115
Length L [mm]	118.7	148.7
Width B [mm]	50	
Height H1 [mm]	68.5	
Height H2 [mm]	85.5	
Centering collar D2 [mm]	Ø 20g6 x 2.5	
Diameter plunger D1 [mm]	Ø 11	
Thread on plunger	M6x16 (external thread) others on request	
Weight [g]	800	850
My, Mz (Transverse forces on the plunger) [Nm]	< 1	
Coupling / bolting on the flange Hole distance [mm] Mounting options M4 Tightening torque (strength class 8.8) [Nm]	42 x 42 4 x M4 through hole (4.3 mm) 3.0	
Connections / Interfaces Power supply Digital IOs EtherCAT CANopen	M12 L-coded M12 A-coded M8 A-coded or M12 Y-coded M8 B-coded	
Degree of protection	IP65*	
Materials (of the external components) Plunger Flange Cover Wiper ring (optional)	Stainless steel (1.4305) Aluminium Stainless steel (1.4301 oder 1.4304) HPU (Hydrolysebeständiges Polyurethan)	

Deviations from standard configuration are possible on request.

* in test phase

SMELA GmbH reserves the right to make changes as a result of technical improvements or new findings.

Dimensions, mechanical connection

Size | Flange width 50 | Stroke 85 mm

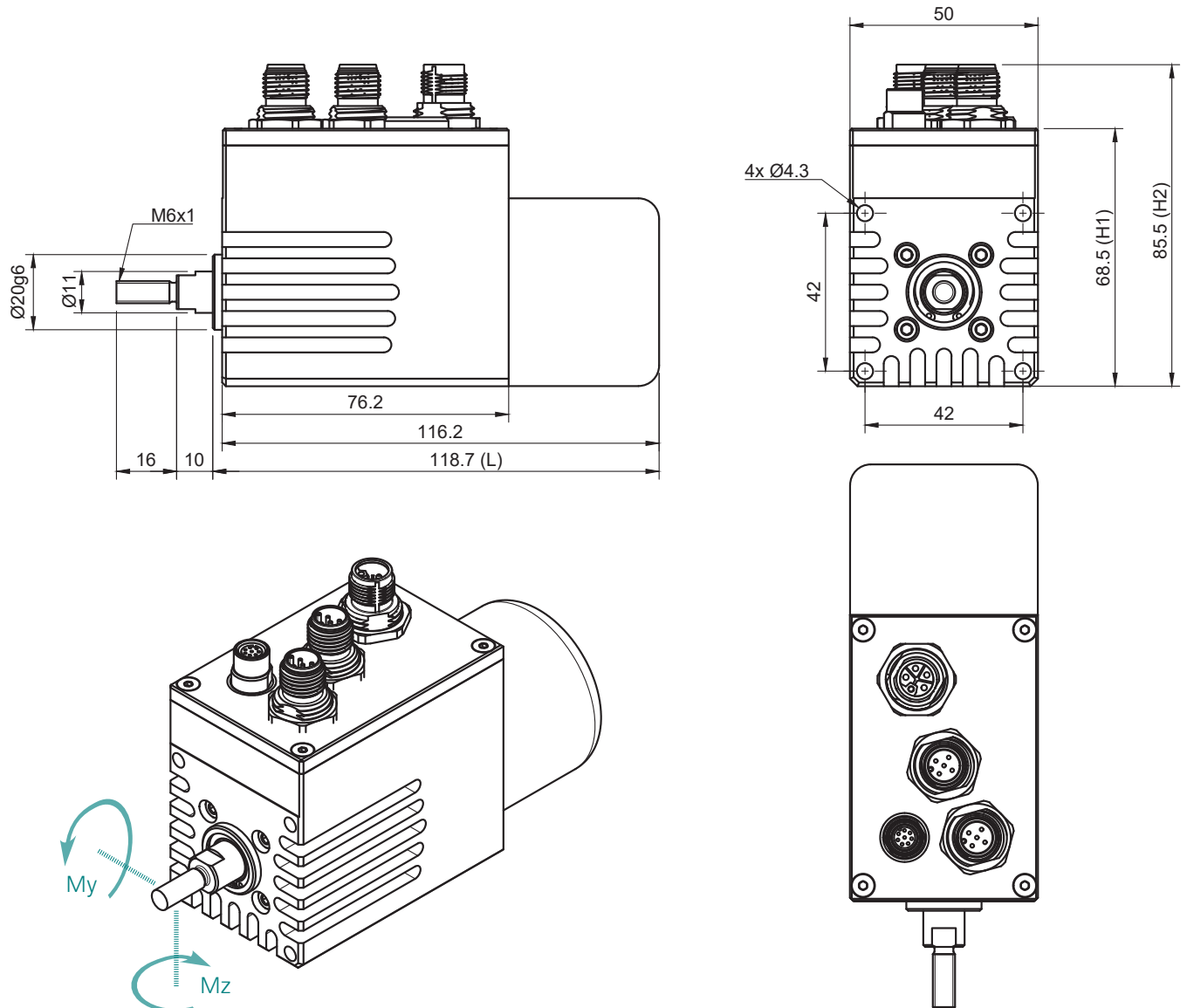

Plan the actuators directly into your design!

Latest data sheets and CAD models are available on request via sales@smela.com or at: www.smela.com

Dimensions, mechanical connection

Size | Flange width 50 | Stroke 115 mm

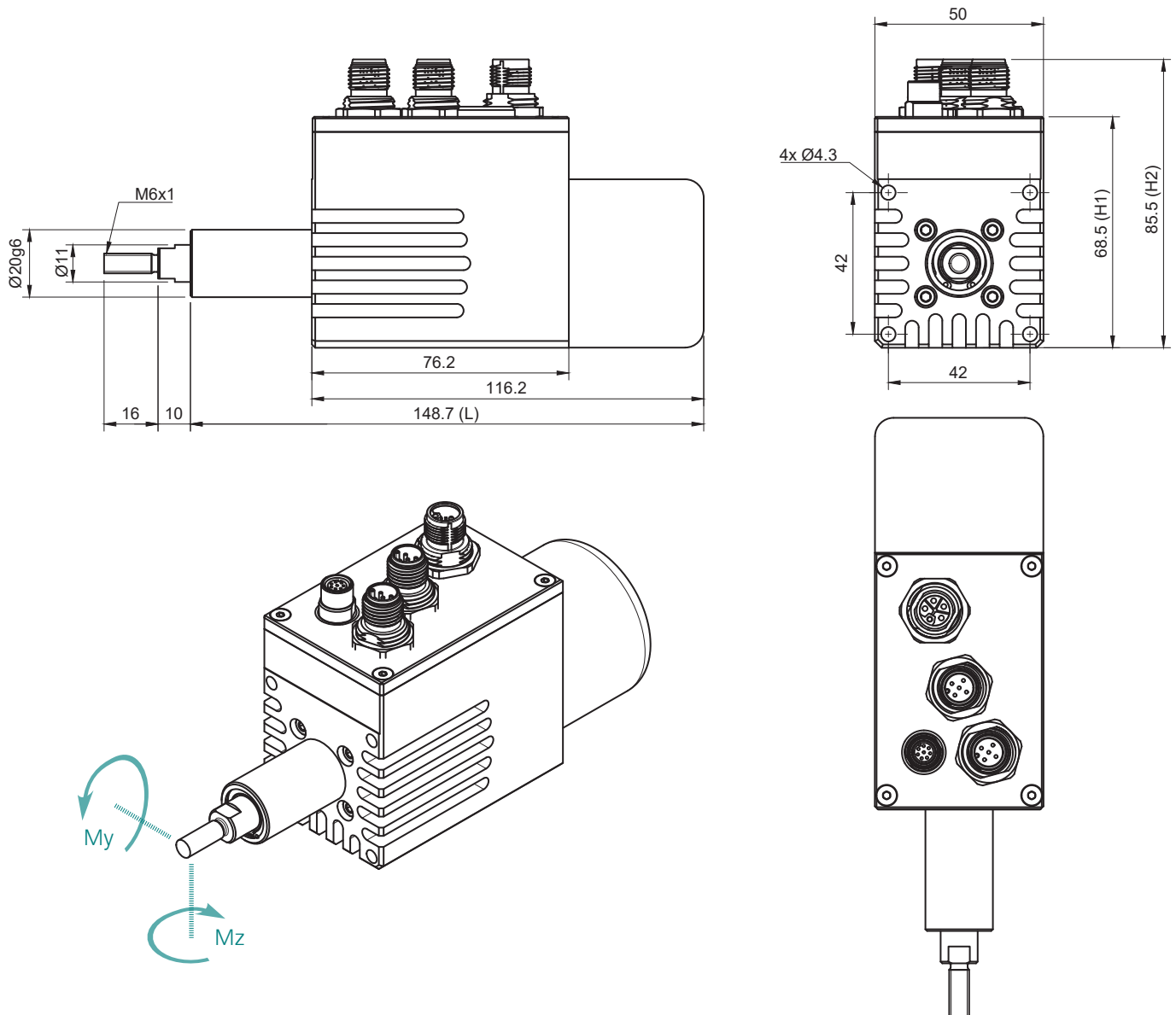

Mechanical performance data

Size | Flange width 50

The following maximum achievable performance data are based on the permissible load capacity for the thread pairs used and the motor. Limiting parameters are, among others, the static load capacity of the nut configuration, the permissible sliding speed and the permissible peak and nominal currents of the integrated servomotor (see following page). In practice, due to the reciprocal effects of influences, it may not always be possible to reach the limit values, in particular peak force and maximum speed cannot occur simultaneously. Any increase in the load leads to a reduction in the permissible sliding speeds and vice versa. Please do not hesitate to ask us about the technical feasibility of your motion profiles.

Lead screw configuration	Limit load capacity ¹⁾	Backlash ²⁾	Peak force ³⁾ / Peak current ³⁾	Nom. force ⁴⁾ / Nom. current ⁴⁾	Max. speed ⁵⁾	Max. acceleration ⁶⁾	Positioning time ⁷⁾
	N	mm	N / A	N / A	mm/s	m/s ²	ms
High helix							
S100	370	approx. ±0.1	300 / 12	125 / 5	500	25	120
S150	370		200 / 12	83 / 5	750	37.5	85
S240	315		125 / 12	52 / 5	1.200	60	65
Trapezoidal thread							
T020	750	approx. ±0.1	750 / 6	625 / 5	50	2,5	900
T040	750		750 / 12	313 / 5	100	5	450

SMELA GmbH reserves the right to make changes as a result of technical improvements or new findings.

Explanatory footnotes:

- 1) Limit load capacity: max. static force and axial load capacity of the internal mechanics; exceeding loads are not permissible and must be absorbed by external mechanics or brakes
- 2) The backlash is wear-dependent, the wear is dependent on load and dynamics
- 3) Maximum permissible force and the corresponding proportional phase current must not be exceeded in order to protect the internal mechanics. The max. phase current of the rotary motor I_{max} may furthermore be applied for max. 20 seconds in order not to exceed the internal limit temperature starting from an initial temperature of the actuator of 20°C
- 4) Permissible permanent nom. force / permissible nom. phase current not to exceed the internal limit temperature at an ambient temperature of 20 °C. Determined by a slow and permanent movement under load (quasi-static method) for the normal case, i.e. the connection of the actuator to a metal body with a thermal contact resistance to air of 1.7 K/W. In case of a worse thermal coupling, limit to the nom. current of the worst case (3 A, see chart on page 8 and footnote 11)
- 5) The max. speed depends on voltage. The characteristics shown refer to a nom. voltage of 24 V (at the actuator);
- 6) During braking (negative acceleration), energy is generated and fed back into the DC link; if the DC link is not capable or regenerative braking, care must be taken to ensure that the DC link capacitance is adequately dimensioned and that an additional braking resistor is used
- 7) Over the stroke of 45 mm with a rated voltage of min. 24 V (at the actuator), without load

Plan the actuators directly into your design!

Latest data sheets and CAD models are available on request via sales@smela.com or at: www.smela.com

Electrical performance data

Size | Flange width 50

	Symbol	Unit	Min.	Typ.	Max.
Power supplies, general					
Power supply logic	U_{logic}	V_{dc}	19	24	30
Power supply motor	U_{motor}	V_{dc}	19	24	30
Current consumption logic	I_{logic}	mA	100	110	310
Current consumption motor	I_{motor}	A	0	3	15
Operating temperature ⁹⁾	T_{amb}	°C	+5	+20	+40
Internal temperature limit ⁹⁾	$T_{\text{int,max}}$	°C			+90
Digital IO logic			PNP 24 V		
CANopen protocol			CiA 301 v4.2, CiA 305 v2.2.13 and CiA 402 v3.0		
EtherCAT protocol	-	-	CoE, CiA402, IEC61800-7-301		
Motor parameters (for parameterization and profile calculation)					
Max. permissible speed (equal to no-load speed at 24 V) ⁸⁾	$n_{\text{max}} = n_0$	min^{-1}	3,025		
Max. acceleration ⁶⁾	α_{max}	rad/s^2	16,610		
Max. motor phase current ³⁾	I_{max}	A	12		
Thermal time constant (winding) ¹⁰⁾	$\tau_{\text{th,w}}$	s	20		
Nom. current ⁴⁾ poor thermal connection ¹¹⁾ good thermal connection ¹²⁾	$I_{\text{N,wc}}$ $I_{\text{N,nc}}$	A A	3 5		
Max. torque (at I_{max})	M_{max}	mNm	750		
Torque constant	k_M	mNm/A	62.5		
Speed constant ¹³⁾	k_n	min^{-1}/V	126		
Terminal resistance	R_S	$\text{m}\Omega$	585		
Terminal inductance ¹⁴⁾	L_S	μH	300		
Electrical time constant ¹⁴⁾	τ_{el}	ms	0.512		
Number of pole pairs	z_p	-	7		
Rotor inertia ¹⁵⁾	J	$\text{g} \cdot \text{cm}^2$	455		

SMELA GmbH reserves the right to make changes as a result of technical improvements or new findings.

Explanatory footnotes:

- 8) The characteristic data refer to a nominal voltage of 24 V (at the actuator);
9) Max. permissible ambient temperature; The internal temperature limit must not be exceeded
10) The max. phase current I_{max} is to be applied for a duration of max. $\tau_{\text{th,w}}$ in order not to exceed the internal temperature limit of $T_{\text{int,max}}$ starting from an initial temperature of the actuator $T_{\text{int}} = T_{\text{amb}} = 20^\circ\text{C}$
11) With thermal insulation (actuator horizontal in static air at 20°C, 80% humidity, thermal contact resistance to air = 5 K/W)
12) When connected to a metal body with a thermal transfer resistance to air of 1.7 K/W
13) Related to measured peak voltage, no RMS value, phase to phase
14) Phase to phase; measured at 1 kHz, 1V rms
15) Calculated value without linear unit

Connectors, interfaces

Automotive variants (A) with M12 connectors

Power supply 24 V_{DC} M12, L-coded, 5 pin, male

Pin	Function
1	not used
2	0 V _{DC} (Power supply motor)
3	not used
4	24 V _{DC} (Power supply motor)
5	FE

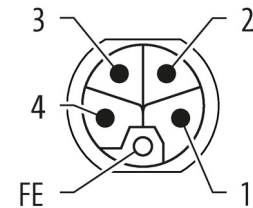

Digital IN, control (IDIO variant) M12, A-coded, 4/5 pin, male

Pin	Function
1	not used
2	Control command „Retract“
3	0 V _{DC}
4	Control command „Extend“
5	not used

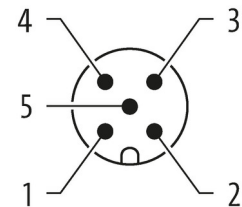

Digital OUT, feedback (IDIO variant) M12, A-coded, 5 pin, male

Pin	Function
1	24 V _{DC} (Power supply logic)
2	Feedback „Retracted“
3	0 V _{DC} (Power supply logic)
4	Feedback „Extended“
5	FE (optional)

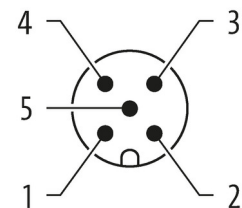

EtherCAT (ICAT variant) M12, Y-codiert, 8 pin, female for in & out

Pin	Function
1	TX+
2	TX-
3	RX+
4	RX-
5	0 V _{DC} (Power supply logic)
6	24 V _{DC} (Power supply logic)
7	24 V _{DC} (Power supply logic)
8	0 V _{DC} (Power supply logic)

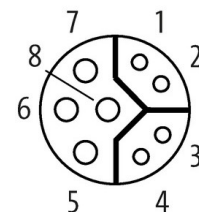

Connectors, interfaces

Standard Variants (S) with M8 & M12 connectors

Power supply 24 V_{DC}

M12, L-coded, 5 pin, male

Pin	Function
1	0 V _{DC} (Power supply logic)
2	0 V _{DC} (Power supply motor)
3	24 V _{DC} (Power supply logic)
4	24 V _{DC} (Power supply motor)
5	FE

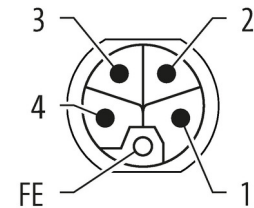

CANopen

M8, B-coded, 5 pin, male for in, female for out

Pin	Function
1	CAN V+
2	CAN SHIELD
3	CAN H
4	CAN L
5	CAN GND

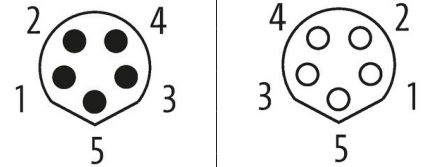

EtherCAT

M8, A-coded, 4 pin, female for in & out

Pin	Function
1	TX+
2	RX+
3	RX-
4	TX-

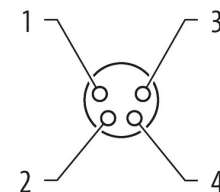

IO Connector

M12, A-coded, 12 pin, female

Pin	Function
1	DIO V+
2	DIO GND
3	DIN 1
4	DIN 2
5	DIN 3
6	LIMIT 1
7	LIMIT 2
8	DOUT
9	AIN+
10	AIN-
11	not used
12	not used

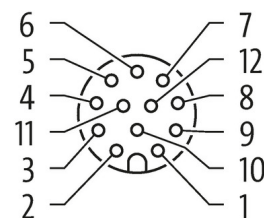

SMELA GmbH
Liebknechtstraße 55
DE-39108 Magdeburg
www.smela.com
info@smela.com | sales@smela.com